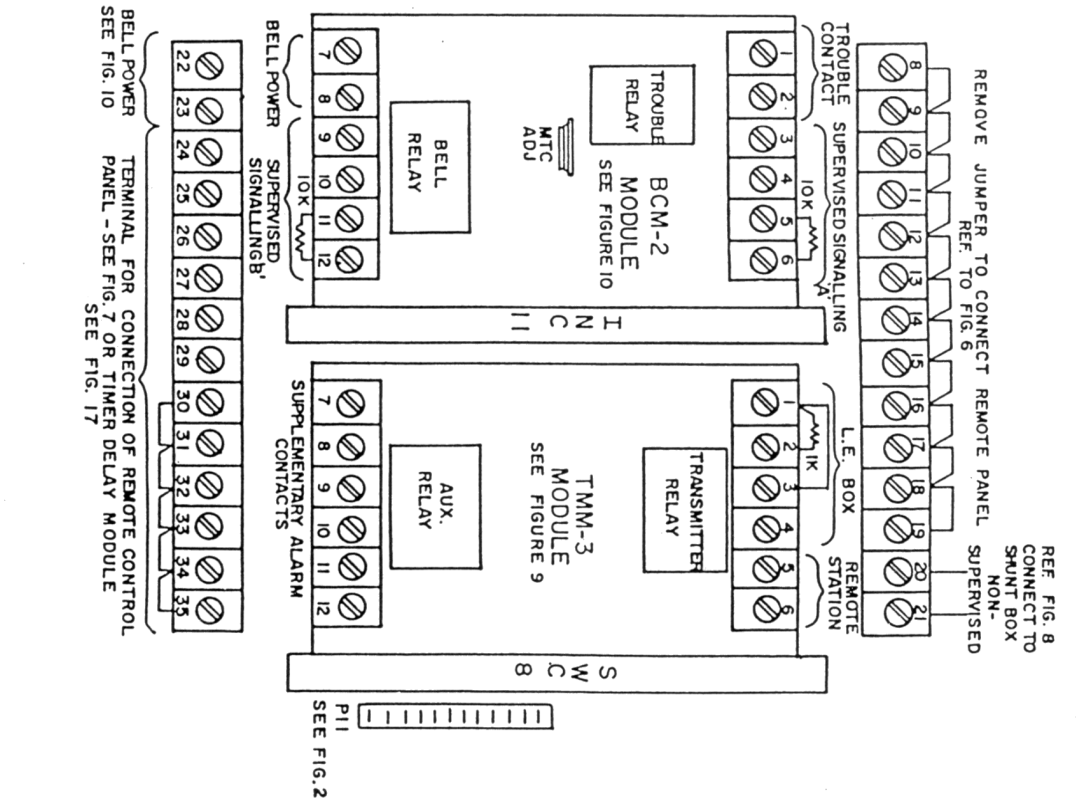
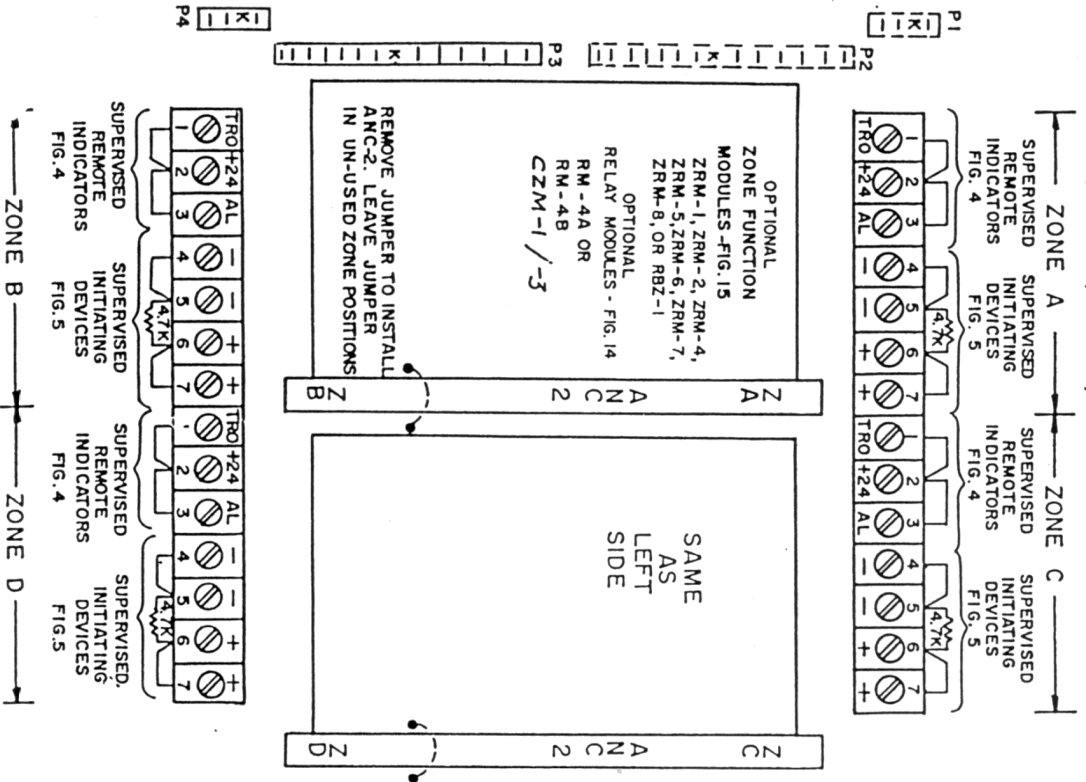
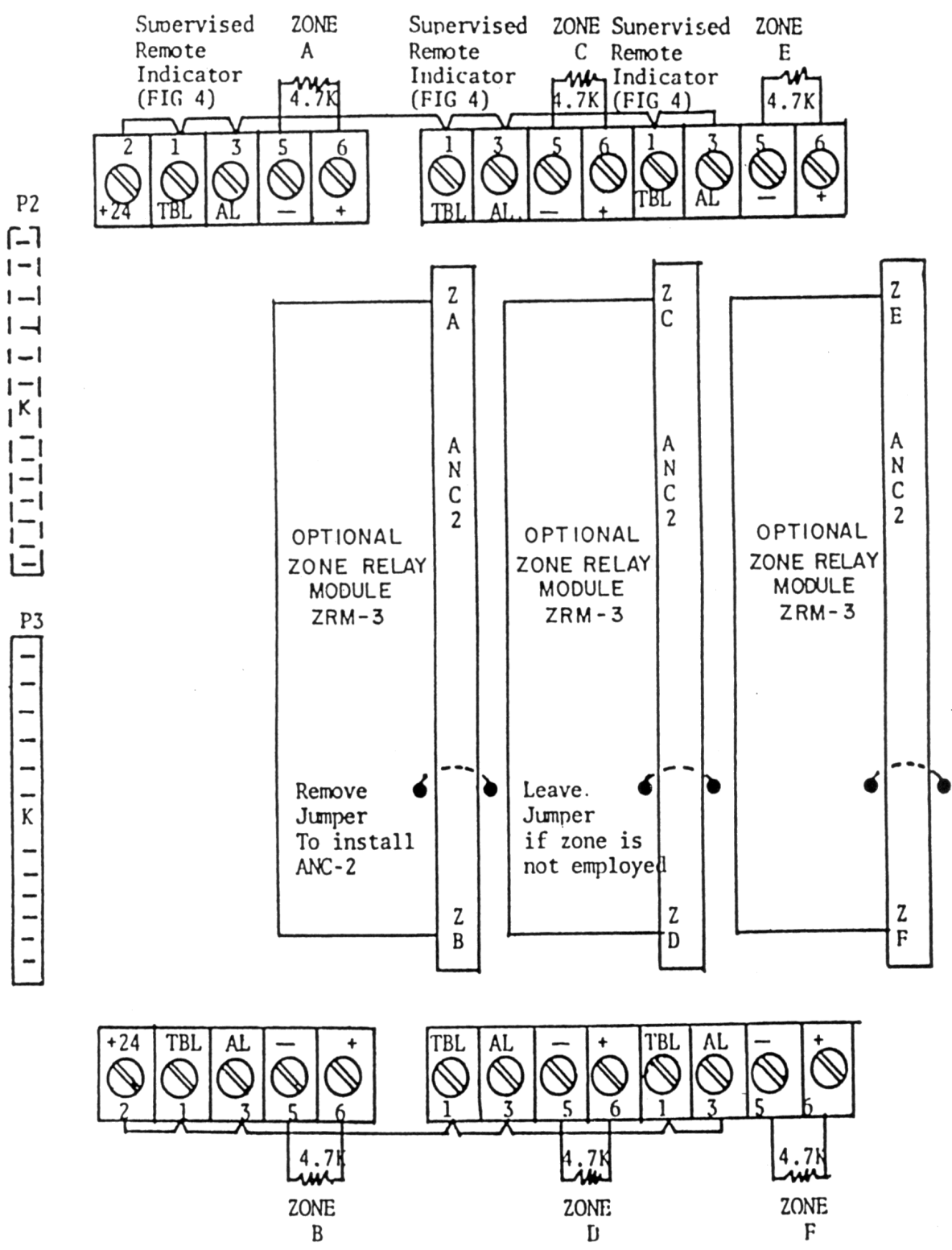

FIGURE 3 - MODULE AND TERMINAL LOCATIONS (SHEET 1 OF 2)

MZB-4, MZB-8, MZB-12, OR ZONE SECTION OF MCB-108

CONTROL SECTION OF MCB-108 OR MCB-114





CLASS "B" SUPERVISED

OTES:

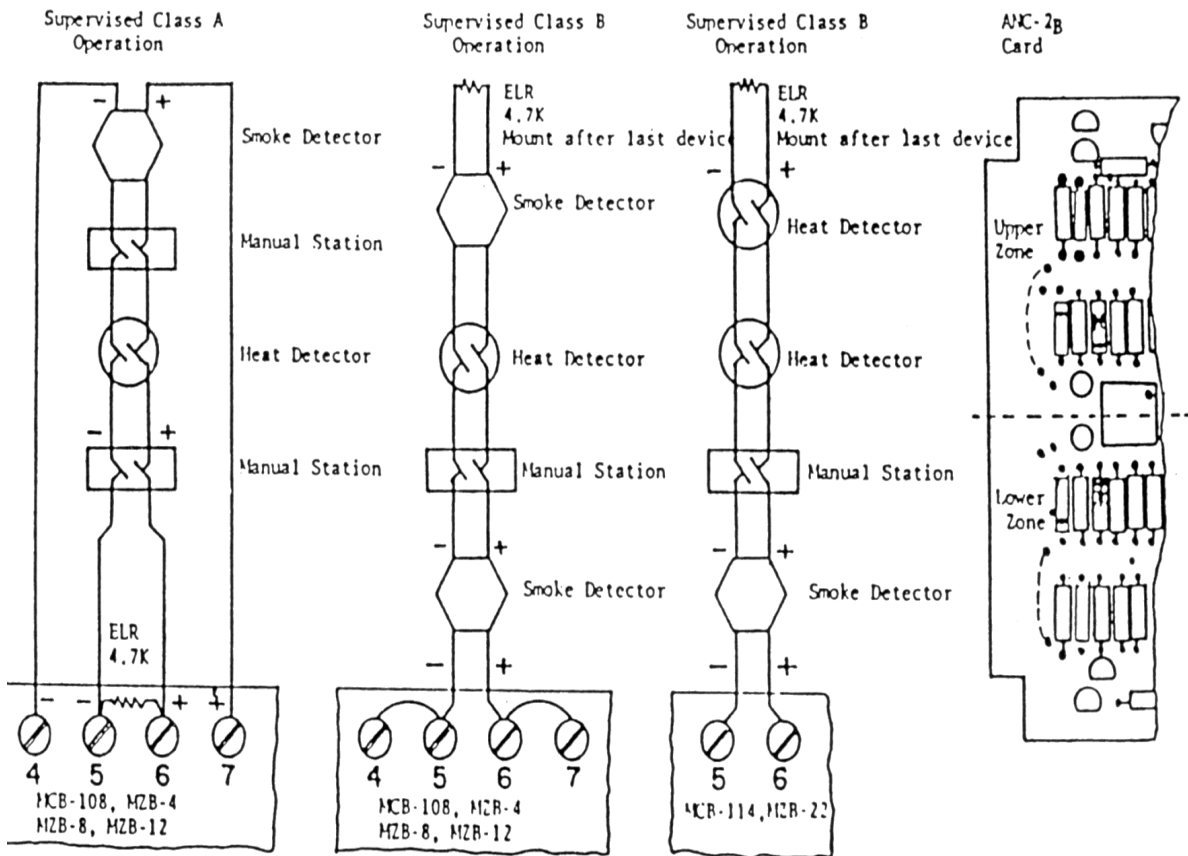

NOTES:

1. Detection loop specifications

Operation:

Class A or Class 8 for MCB-108. MZB 4. MZB-8. MZB12 and Class 8 only on MCB-114. MZB-22.

Voltage, standby: 23VDC, 60 mV p-p

Current required to ensure alarm: 15mA minimum

Short circuit current: 55 ma msx

Supervision current: 5ma

End of line resistor: 4.7K, 5%

Maximum resistance per side: 100 Ohms

Maximum total zone resistance: 100 Ohms

2. Compatible. U.L. listed. 2 wire detector available from fire-Lite, include the following series:

See appendix A

3. Initiating Devices include: Manual itation. heat detectors. smoke detectors. ionization detectors. waterf low alarm devices. coded manual stations.

4. Inhibit latching circuit by removing diode marked with a 0 from zone card if coded manual stations are connected to it zone .
5. Use model WFC If the local authority having jurisdiction requires waterflow service without a disable capability.
6. Smoke and Ionization detectors requiring separate 24VDC power can be powered from master control board Terminal 24 (-) and Terminal 35 (+). See table I for current limitations. Use end of line relay (SDLR-8) to supervise power circuit wiring.
7. Caution is advised when using 2 wire detector containing supplementary relays or Indicators since their operation can be ensured. Example: activation of a manual station, heat detector, or other shorting type detector will shunt operating current from the 2 wire detectors on the same zone thereby preventing their operation.
8. Detector loop current is sufficient to ensure the alarming of one detector per zone.
9. Detector loop is & Power limited circuit, which may be connected to limited energy cable.
10. Compatible four wire detectos available from Fire-Lite include SD34-24, CP-715.

FIGURE 8-SHUNT TYPE- MUNICIPAL BOX CONNECTIONS

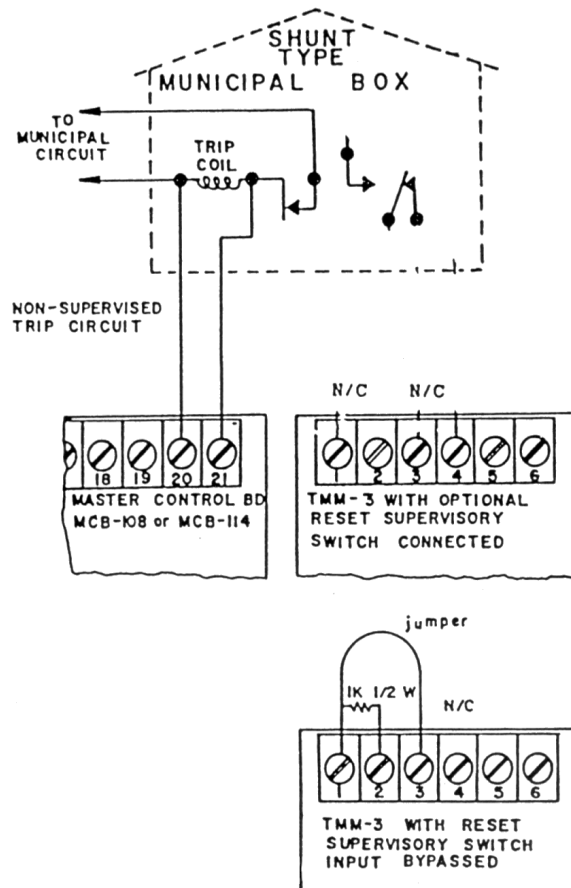

NOTES:

1. The shunt connection is recognized only as a supplementary signalling unit as part of a local control unit and is not recognized as an auxiliary control unit connection per NFPA Number 728.
2. Connect master control board terminal 20 & 21 in shunt (parallel) with municipal box trip coil.
3. If box is equipped with a reset supervisory switch, connect switch as follows:
 - A.. Coffnon to TMM-3 Terminal 1
 - B. Normally closed to TMM-3 Terminal 3
 - C. Normally open to TMM-3 Terminal 4

FIGURE 9 -TRANSMITTER MODULE (TMM-3)

NOTES:

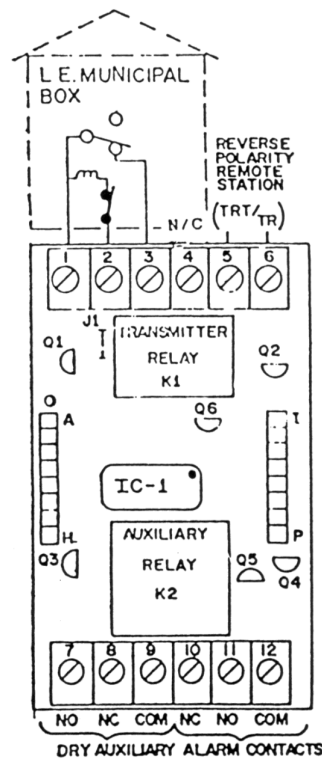

1. Local Energy Municipal Box

(Supervised Circuit)

- A. When a local energy municipal box is to be employed. remove the 1k, 1/2W resistor from terminals 1 and 2. If the box is equipped with a reset supervisory switch. remove the jumper between terminals 1 and 3.
- B. Connect the auxiliary trip coil to terminals 1 and 2.
- C. Nominal trip coil characteristics should be:
 1. Trip current . 0.25 Amperes
 2. Coil voltage . 3.65VDC

3. Coil resistance - 14.6 OHMS
- D. Limit the total interconnecting wire resistance between panel and trip coil to 5 OHMS.
- E. Connect the reset supervisory switch as follows:
 1. Switch common to Terminal 1
 2. Normally closed contact to Terminal 3
 3. Normally open contact to Terminal 4
- F. Wiring must comply with N.F.P.A. 728-Auxiliary - 2. Remote Station Connection (Non-Supervised)
 - A. Remove jumper J1 unless local regulations specifically prohibits the transmission of a trouble signal
 - B. A U.L. Listed polarity sensitive remote station rated for 18 to 28 VDC operation may be connected to terminals 5 and 6.
 - C. Nominal remote station output levels:
 1. Alarm: 24VDC with Terminal 5 Positive
 2. Normal: 24VDC with Terminal 6 Positive
 3. Trouble: 0 VDC if jumper J1 has been removed. Trouble is not transmitted if jumper J1 is installed.
 4. Do not short output. if a remote station is not employed leave Terminal 5 and 6 open.
3. Supplementary Alarm Contacts (Non-Supervised)
 - A. Two sets of form C Contacts are provided at Terminals 7 to 12. These contacts are activated by an alarm.
 - B. Contacts are rated at 10 AMP. 28VDC/115VAC resistive.

FIGURE 10- BELL CIRCUIT (BCM-2)

NOTES:

1. Modes of Operation

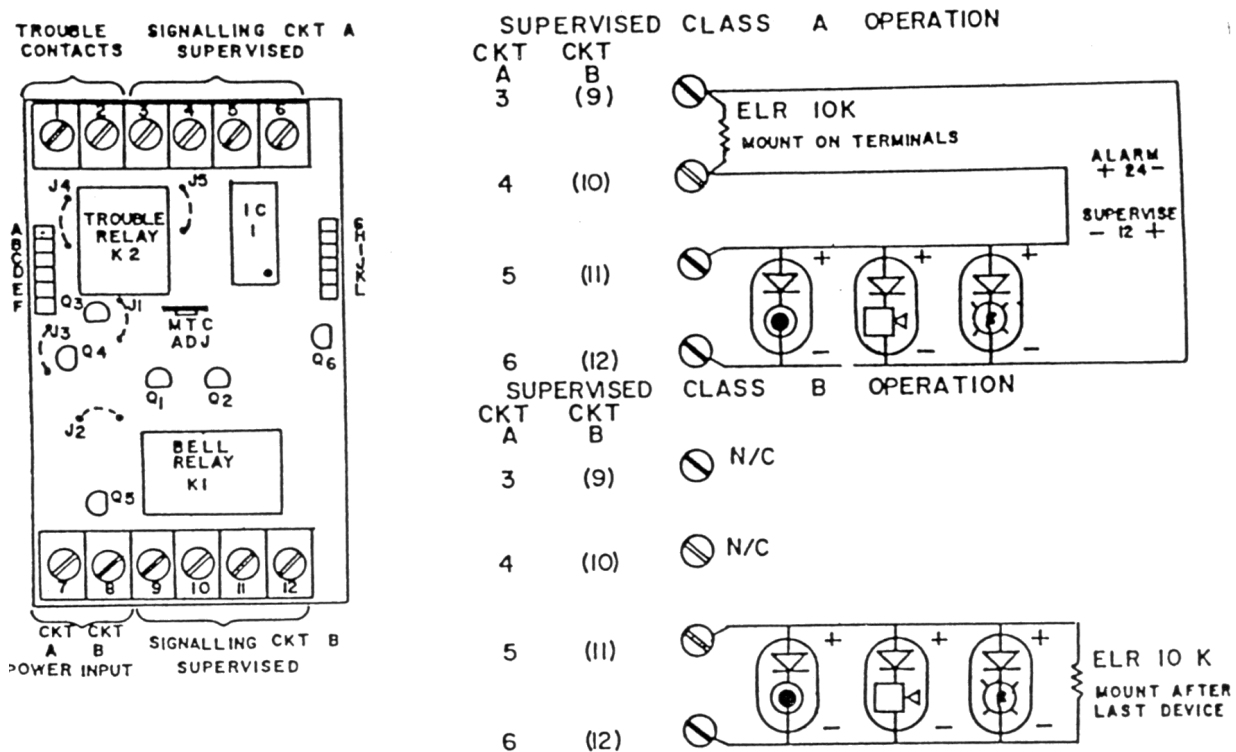

- A. For non-disconnectable bells remove jumper 'J3' but leave jumper 'J2'
 - B. For disconnectable bell remove jumper 'J2' but leave jumper 'J3'
 - C. To convert from a steady bell signal to a March Time (MIC) bell signal. remove jumper diode 'J1'
 - D. Select normally open or normally closed trouble contacts by removing jumper 'J4' or jumper 'J5'. Remove J4 to obtain an open contact during normal system operation, or remove 'J5' to obtain a close contact during normal operation.
2. Trouble output (non-supervised)
- A. Normally open or normally closed trouble contact is provided at terminals 1 and 2. This contact is activated by a system trouble and is rated 2Amps. 28VDC (resistive)
3. Power limited Indicating circuits. (supervised)
- A. Connect signalling circuits as shown
 - B. See table for maximum signalling current.
 - C. Size wire for a maximum voltage drop of 2VDC.
 - D. Use polarized. U.L. listed. signalling devices with a minimum rated voltage range of 18 to 30VDC.
 - F. Compatible fire-Lite model include BDP-24 Bell. HDP-24 Horn, and STH-72-24D Strobe Horn.
4. Signalling power is connected to the bell module via terminal 7 (positive input CKT A). terminal 8 and limitation are outlined in the following table:

SUPPLY USED	CONNECTION REQUIRED	CURRENT LIMITATION (AMPERES) EACH CIRCUIT	TOTAL OF BOTH
PSM-104 (STANDARD)	CKT A: BCM Terminal 7 to MCB Terminal 22, CKT: BCM Terminal 8 to MCB Terminal 23, Common: Internally Connected	2*	2.25*
PSM-104a (OPTIONAL)	CKT A: BCM Terminal 7 to PSM-104A Terminal 6, CKT B: BCM Terminal 8 to PSM-104A Terminal 6, Common: MCB Terminal 24 to PSM-104A Terminal 5	1.75	3.5
PSM-204A (OPTIONAL)	CKT A: BCM Terminal 7 to PSM-204A Terminal 10, CKT B: BCM Terminal 8 to PSM-204A Terminal 6, Common: MCB Terminal 24 to PSM-204A Terminals 5 and 9	3.0 Class A 3.5 Class B	7.0

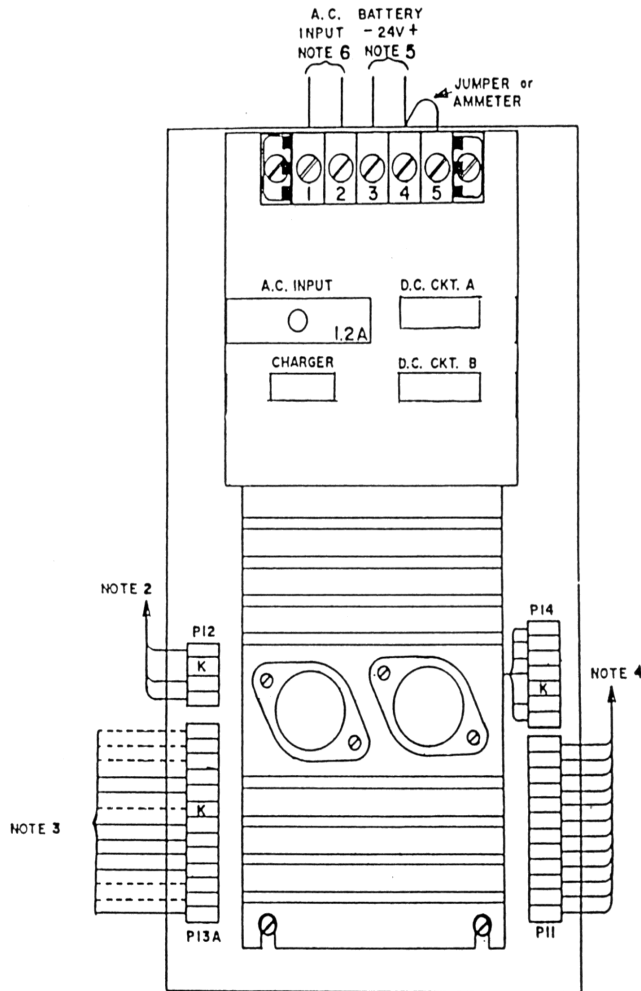

NOTES:

1. PSM-104 mounts to
sis.
2. A 3 wire cable normally connected to P4 (lower left plug) on last (closest) master board. If zone bell modules are employed see figure 16 for additional Information.
3. Standard system (no optional chassis): A 7 wire cable connected to P3 (lower left side) on last (closest,) master board. System with optional chassis: A 13 wire jumper cable connected to adjacent plug (P13B) on optional chassis.
4. A 12 wire cable connected to P11 (right side) on master control board.
5. A 24V standby battery connects to terminals 3 (negative) and terminal 4 (positive). Battery is float charged to 27.6 volts. Charger has a typical current limit of 1.5 amperes. Battery circuit must be capable of supplying 4 amperes to PSM-104 during a power failure.
6. A.C. power connects to terminals 1 and 2. Standard A.C. input is 120V. 60 HZ. Current consumption at rated load is 1.2 amperes. See Instruction Manual section 3.4.
7. Install protective cover over terminal block before energizing system.

right of all optional chas-

FIGURE 11-PSM 102 AR

FIGURE 11
PSM - 102AR

SHEET 2 OF 3

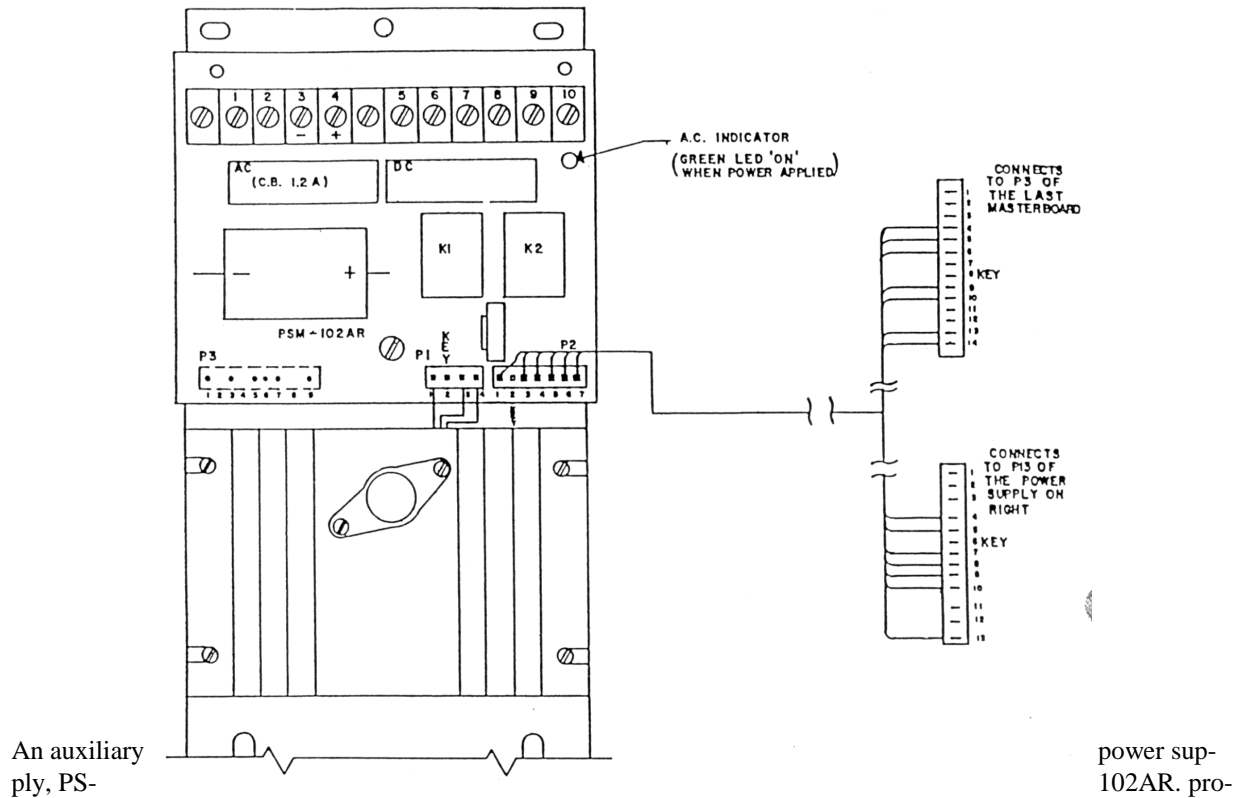

An auxiliary
ply, PS-

power sup-
102AR. pro-

vides two amperes of regulated, adjustable 24VDC smoke power. It also increases the system's zone carrying capacity. Overload protection is provided by means of circuit breaker(s) and/or fuse at input and output of the supply. The green LED lights when AC power is applied. If AC Power indicator fails to light, service system immediately. Loss of AC power will activate system's visual and an audible device.

INSTALLATION

1. Install PSM-102AR to extreme left of all the power supplies.
 2. Connect three plug cable as shown.
 3. Remove jumper from terminal 35 of the master control board (MCB) but maintain term, 30 to 34 jumpered. Connect as shown in the table below.
- | PSM-102AR (KCS) | To | MASTER CONTROL BOARD |
|-----------------|----|----------------------|
| 4. Term. #9 | To | Term. #19 |
| 5. Term. #8 | To | Term. #31 |
6. Connect 120VAC, 60HZ across terminal #1 and #2.
 7. Connect battery (24VDC) across terminal #3(-) And #4(+). Check the polarity when connecting the batteries.
 8. If 'Remote Control Panel' (RCP) is employed then avoid step 5.
 - Connect term. #35 of MCB to term #16 of Remote Control Panel.

-Connect term. #8 of PSM-102AR to term.#2 of RCP.
For more Information on IRCPI see dwg. 110000-3035.

POWER REQUIREMENTS: Input 120VAC. 60HZ. 1.2AMP
 Output 24VDC at 2.0AMP. 24

FIGURE 11 PSM- 108
 OPTIONAL SYSTEM POWER SUPPLY

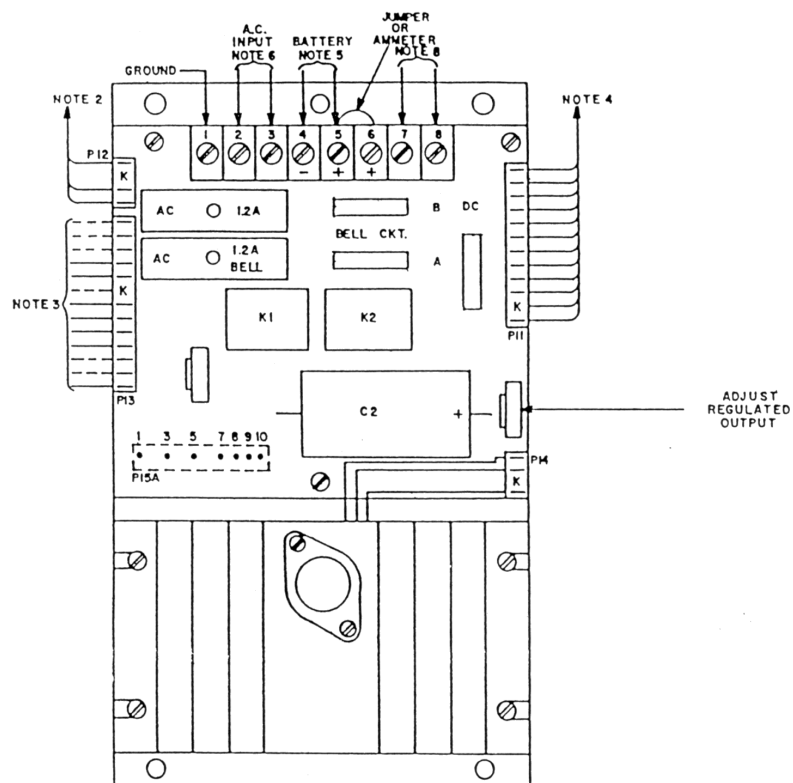

PSM-108 is in optional system power supply without battery charger. It provides two amps of regulated alarm current in addition to 3.5 amps of unfiltered bell power. The PSM-108 with an external battery charger shall be used instead of

PSM-104 when:

- * (1) The alarm current load In table 1 exceeds .750 amp and
- * (2) Ampere-hour calculation In part 3 of table 3 requires greater than 28 ampere-hour battery.

Built-in brownout circuit will engage the secondary source (24v battery) when Insufficient A.C. voltage is detected. Supply outputs: 1) Reguated 24VDC 2 ampere maximum. 2) Two unfiltered, unregulated 24 volt nominal full wave rectified d.c. outputs, used to power bell circuits. Total output current is 3.5 amperes.

Overload protection: A.C. power : two breakers. each 1.2 amperes. Bell power: two PTC, 3.75 amperes.

Battery: 3 amperes.

Battery charger (R45-24):1) Float type with current limiting and voltage foldback circuitry. Output is set to 27.6 volts

- Notes:
1. PSM-108 mounts to right of all optional chassis.
 2. A 3 wire cable normally connected to P4 (lower left plug) on last (closest) master board.
 3. System without auxiliary power supply: A 7 wire cable connected to P3 (lower left side) on last (closest). System with auxiliary power supply: A 13 wire jumper cable connected to adjacent plug (P138) or optional chassis.
 4. A 12 wire cable connected to P11 (right side) on master board.
 5. A 24V stand-by battery connects to terminals 4 (-) and terminal 5 (*)
 6. Connect 120VAC.60MZ across Term #2 and #3.
- Connect ground lead to Term #1. Current consumption at rated load is 2.4 amperes.
7. Remove Jumper from term #35 of MCB-108.
 - 8.. Connect Term #7 and #8 of PSM-108 to Term #35 and #31 of MCB-108 respectively.

FIGURE 12 - AUXILIARY SUPPLIES PSM - 104A/204A

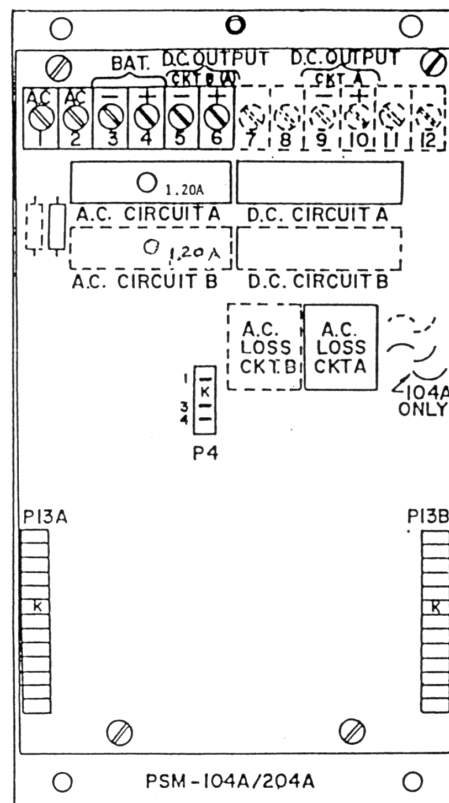

1. On intermediate chassis from 13A to adjacent chassis connect a 7 pin cable on last (closest) master board.
2. Connect a 13 wire

connect a 13 pin jumper cable plug P13B. On left most- from P13A to P3 (lower left side) jumper cable from P138 to adja-

cent chassis plug P13A.

3. Connect the 24VDC (PSM-104A and PSM-204A is unfiltered and unregulated) output as desired. To power bell module (BCM-2) from these supplies refer to figures 2 and 10. To power the Ring-By-Zone module (RBZ-1) refer to figures 2 and 16. Output information is listed below:
 PSM-104A.-Single 3.5 Ampere supply -- Positive output: Terminal 6 and Pin 3 and 4 of Plug 4
 Common Negative Output: Terminal 5 and Pin 1 of Plug P4
 PSM-204A.-Dual 3.5 Ampere Supply .- Positive output Ckt A: Terminal 10 and Pin 3 of Plug P4
 Positive output Ckt B: Terminal 6 and Pin 4 of Plug P4 Common (Negative): Terminal 5 and 9 and Pin 1 of Plug P4
4. A 24V standby battery connects to terminal 3 (negative) and terminal 4 (positive). Maximum battery load during power failure is 4 amperes for PSM-104A and 8 amperes for PSM-204A.
5. A.C. Power connects to terminal 1 and 2. Standard A.C. input Is 120V. 60HZ. Current consumption at rated load is 1.2 ampere for PSM-104AB and 2.4 amperes for PSM-204AS.
6. Install protective cover over terminal block before energizing system.
7. Denotes components used on PSM-204A only.

FIGURE 13-AUXILIARY BELL CIRCUIT AND SUPPLY
 TABLE 1 NOTES

1. If the alarm current load, calculated in Tabel 1, exceeds 0.750 amperes (system supply rating) add an auxiliary regulated supply, PSM-102AR, or PSM-108 increase maximum load current to 2.0 amperes.

SENSISCAN Components	DEVICE (FIRE-LITE MODEL NUMBERS)	NUMBER OF DEVICES	CURRENT PER DEVICE (AMPERES)	TOTAL DEVICE CURRENT (AMPERES)
	SENSISCAN with control board, PSM-104, TMM-3, SWC-8, INC-11, BCM-2. Three zones in alarm all zone modules activated by GEneral Alarm Switch.			.320
	Aux. Supplies (PSM-104A, PSM204A, TA-50)			.000
	Zone Relay Modules (ZRM-1, ZRM-3, ZRM-5)		x .010	=
	Zone Relay Module (ZRM-2)		x .070	=
	Zone Relay Modules (ZRM-4, ZRM-6, ZRM-7)		x .014	=
	Zone Relay Module (ZRM-8)		x .028	=
	Time Delay Module (TDM-1)		x .040	=
	Ring-By-Zone Modules (RBZ-1)		x .032	=
	Relay Module (RM-4A, RM-4B)		x .014	=

	Bell CKT. and Supply (PSM-104B, PSM 204B, PSM-404B, PSM-408B)		x .018	=
	Dual Zone Card (ANC-2, WFC-1, WFC-2)		x .012	=
	Cross Zone Delay Release Module (CZM-1)		x .090	=
	Cross Zone Delay Release Module (CZM-3)		x .160	=
	Circuit Verification CArd Module CVC-2		x .015	=
External Components	Two Wire Detector Heads-Standby Current (SD-12, SD-32, CP-700 Series)		x .0001	=
	Four Wire Detector Head (SD14BW, Standby)		x .0001	=
	Four Wire Detector Head (SD34-24VDC, Standby)		x .00015	=
	Ebd of Line Relay (SDLR-B, Use with Four Wire Detectors)		x .025	=
	Above 30 Zones, Add. .050 for every additional 10 Zones		x .050	=
				=

Alarm Current Load on Regulator (Add Last Column)

FIGURE 13-AUXILIARY BELL CIRCUIT AND SUPPLY
PSM-104B, 204B, 404B, 408B

2. Table 1 is based on:

- a) Ten percent of the total number of zone, but not less than three zones, being in the alarmed state; and
- b) All zone functions being activated by General Alarm Switch
- c) Cross Zone Delay Release Modules (CZM-1 & CZM-3) in alarm

TABLE 2 : A.C. CURRENT REQUIREMENTS

POWER SUPPLY TYPE	NUMBER USED	MAXIMUM INOUT CURRENT (AMPERES)	TOTAL INPUT CURRENT (AMPERES)
System Supply (PSM-104)			1.20
Auxiliary Supplies (PSM-104A, PSM-104B, PSM-102AR, PSM-404B, TA-50)		X 1.20	=
Dual Auxiliary Supplies (PSM-204A, PSM-204B, PSM-108, PSM-408B)		X 2.40	=
Total A.C. Current Requirements at 120V (Add Last Column)			

TABLE 2 NOTES

- 1. Table 2 is based on full load condition.

TABLE 3: STANDBY BATTERY REQUIREMENTS
PART 1: CALCULATION FOR BATTERY STANDBY CURRENT

DEVICE (FIRE-LITE MODEL NUMBERS)	NUMBER OF DEVICES	CURRENT PER DEVICE (AMPERES)	TOTAL DEVICE CURRENT (AMPERES)
SENSISCAN with control board PSM-104, TMM-3, SWC-8, INC-11, BCM-2 Note: AC power off, visual & audible trouble signal			.055
Zone Relay Modules (ZRM Series)			.000
Unreg. Aux. Supplies (PSM-104A, PSM-204A)			.000

Regulated Aux. Supply (PSM-102AR, PSM-108)		x .005	=
Bell Ckt. and Supply (PSM-104B, PSM-204B, PSM-404B, PSM-408)		x .005	=
Master Zone Boards (MZB Series)		x .002	=
Dual Zone Cards (ANC-2, WFC-1, WFC-2)		x .012	=
Ring-By-Zone (RBZ-1)		x .003	=
Time Delay Module (TDM-1)		x .006	=
Cross Zone Delay Release Modules (CZM-1, CZM- 3)		x .025	=
Tone Amplifier (TA-50)		x .30	=
Two Wire Detector Heads (SD-12, SD-32, CP-700 Series)		x .0001	=
Four Wire Detector Head (SD14BW)		x .00015	=
Four Wire Detector Head (SD34-24VDC)		x .005	=
Zone Coder Model ZC-83		x .055	=
Circuit Verification Card Model CVC-2		x .015	=
End of Line Relay (SDLR- B, not required for 2 wire detectors)		x .025	=
Remote Indicator (RZI Series-for Sonalert)		x .012	=
Remote Station Loading (Enter only if trouble transmission inhibited)			=
Remote Trouble Signaling Devices-Bells, Etc.			=
Other Devices using SEN- SISCAN Power			=
			=
Battery Standby Current (Add Last Column)			=

PART 2: CALCULATION FOR ALARM LOADING ON BATTERY

POWER SUPPLY TYPE	NUMBER USED	MAXIMUM ALARM CURRENT (AMPERES)	TOTAL TYPE CURRENT (AMPERES)
System Supply (PSM-104)			4
Auxiliary Supplies (PSM-104A, PSM-104B, PSM-404)		x 4	
Tone Amplifier (TA-50)		x 4	
Dual Auxiliary Supplies (PSM-204A, PSM-204B, PSM-408)		x 8	
Auxiliary Regulated Supply (PSM-102AR)		x 2.5	
Battery Alarm Load (Add Last Column)			

PART 3: CALCULATE AMPERE-HOURS

1. Battery standby current from part 1		
2. Standby time in hours (generally 24 or 60 hrs.)*		
3. Standby ampere-hours, multiply line 1 by line 2		
4. Battery alarm load in amperes		
5. Alarm time in hours		
6. Alarm ampere-hours, multiply line 4 by line 5		
7. Total ampere-hours, add line 3 and 6		

8. Select battery from part 4 with ampere-hour rating larger than line 7. Indicate battery selected on marking label attached to control unit door.

PART 4: BATTERY SELECTION

AMPERE-HOUR RATING	BATTERY (FIRE-LITE PART NUMBER)	CABINET SIZE(S)
9	Four (4) Globe-Union (GC-690)	ALL
18	Two (2) Eagle Picher (GC-1218)	ALL
23	Two (2) Globe-Union (GC-1220)	ALL
28	Two (2) Globe-Union (GC-128)	C.D. (with ALL Supplies on back plate)

*NFPA 72A and 72D required 24 hours standby. NFPA 72B and 72C requires 60 hours standby.

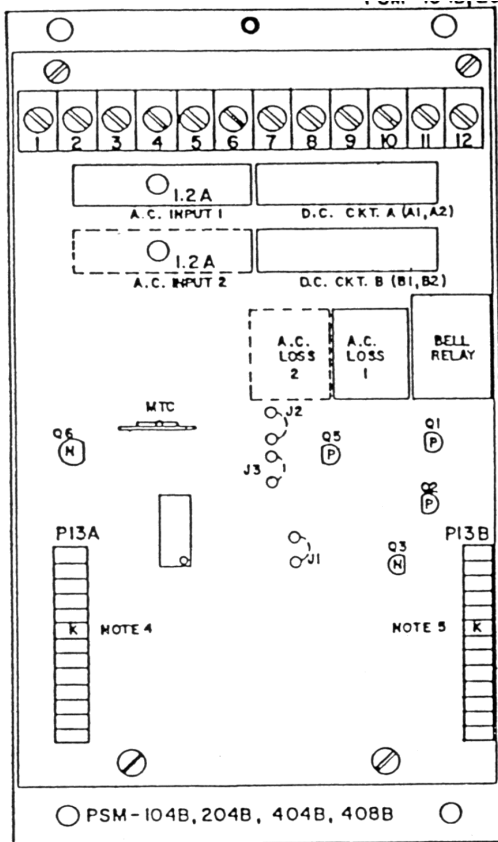

POWER CONNECTIONS

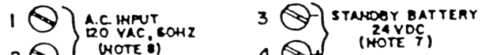

SUPERVISED CLASS A OPERATION (PSM-104B, 204B)

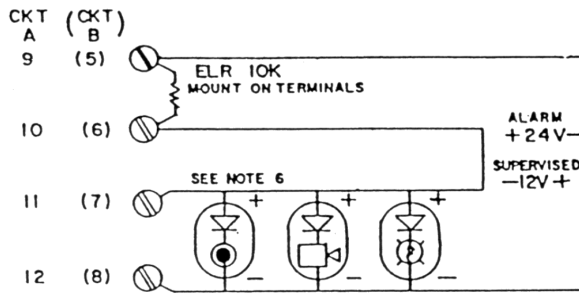

SUPERVISED CLASS B OPERATION (PSM-104B, 204B)

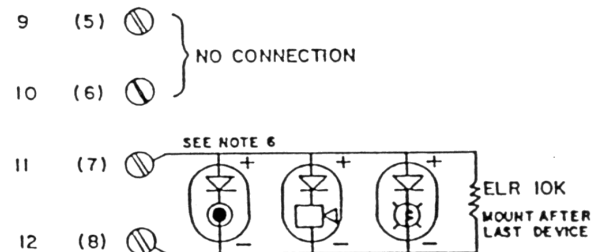

SUPERVISED CLASS B OPERATION (PSM-404B, 408B) CIRCUIT

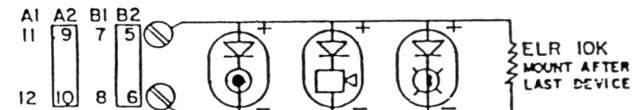

NOTES:

1. For non-disconnectable bell remove jumper J3 but leave J2.
2. For disconnectable bell remove jumper J2 but leave J3.
3. To convert from a steady bell signal to a March Time (MTC) bell signal, remove jumper J1. March Time Rate is adjusted using "MTC" potentiometer.
4. On intermediate chassis connect a 13 pin jumper cable from 13A to adjacent chassis plug P13B. On left most chassis, connect a 7 pin cable from P13A to P3 (lower left side) on last (closest) master board.
5. Connect a 13 wire jumper cable from P13B to adjacent chassis plug P13A.
6. Connect signalling circuits as shown. Use polarized, U.L. listed, signalling device with a minimum rated voltage range of 18 to 30VDC. Size wire for a maximum drop of 2VDC. Compatible FIRE-LITE model include BDP-24 Bell, HDP-24 Horn, and STH-72-24D Strobe Horn.

	Maximum Load Per Circuit	# of Circuits
PS-4048	.85 ampere	4
PSM-104B	1.75 ampere	2
PSM-408B	1.75 ampere	4
PSM-204B	3.5 ampere	2

7. A 24V standby battery connects to terminal 3 (negative) and terminal 4 (positive). Maximum battery load during power failure is 3.5 amp for PSM-104AB, PSM-404B and 7 amperes for PSM-204AB, PSM-408B.
8. A.C. power connects to terminals 1 and 2. Standard A.C. input is 120VAC, 60HZ. Current consumption at rated load is 1.2 amperes. for PSM-104AB, PSM-404B, and 2.4 amps for PSM-204AB, PSM-408B.
9. Install protective cover over terminal block before energizing system.
10. - - Denotes components used on PSM-204B and PSM-408B only.
11. Both circuits are power limited.

